

LT-PIGE-804GBTME



User Manual
Version 1.0

All Rights Reserved

This document contains information, which is protected by copyright. Reproduction, adaptation or translation without prior permission is prohibited, except as allowed under the copyright laws.

Disclaimer

Barox Kommunikation provides this manual without warranty of any kind, expressed or implied, including but not limited to the implied warranties of merchantability and fitness for a particular purpose. Barox Kommunikation may make improvements and/or changes to the product and/or specifications of the product described in this manual, without prior notice. Barox Kommunikation will not be liable for any technical inaccuracies or typographical errors found in this guide. Changes are periodically made to the information contained herein and will be incorporated into later versions of the manual. The information contained is subject to change without prior notice.

FCC Notice

This equipment has been tested and found to comply with the limits for a Class-A digital device, pursuant to Part 15 of the FCC rules. These limits are designed to provide reasonable protection against harmful interference in a residential installation. This equipment generates, uses, and can radiate radio frequency energy. It may cause harmful interference to radio communications if the equipment is not installed and used in accordance with the instructions. However, there is no guarantee that interference will not occur in a particular installation. If this equipment does cause harmful interference to radio or television reception, which can be determined by turning the equipment off and on, the user is encouraged to try to correct the interference by one or more of the following measures:

- Reorient or relocate the receiving antenna.
- Increase the separation between the equipment and receiver.
- Connect the equipment into an outlet on a circuit different from that to which the receiver is connected.
- Consult the dealer or an experienced radio/TV technician for help.

Caution: Any changes or modifications not expressly approved by the grantee of this device could void the user's authority to operate the equipment.

CE Mark Warning

This is a Class-A product. In a domestic environment this product may cause radio interference in which case the user may be required to take adequate measures.

Industrial Ethernet Switches

Industrial Grade Gigabit Managed Ethernet Switches

User Manual

Version 1.0 (August 2015)

Contents

Overview	1
Software Features.....	1
Hardware Features	2
Package Contents.....	3
Safety Precaution.....	3
Hardware Description	4
Physical Dimensions.....	4
Front Panel.....	5
Top View	5
LED Indicators.....	6
Ethernet Ports	7
Cabling	8
Wiring the Power Inputs	11
Wiring the Fault Alarm Contact	12
Mounting Installation.....	13
DIN-Rail Mounting.....	13
Wall Mounting	15
Hardware Installation	16
Installation Steps.....	16
Trouble Shooting	17
Technical Specification	18

This series is rated IP30 and installation by DIN Rail. Each unit of this industrial gigabit managed Ethernet switch series has 8 IEEE 802.3at compliant ports (30W/port) and 4 dual-rate (100/1000) SFP slots, suitable for applications that require high bandwidth and long distance communication.

In order to prevent unregulated voltage, this series provides high EFT and ESD protection. This also allows it to function in harsh environments, as well as support power redundancy with a dual power input design with reverse polarity protection. The built-in relay warning function alerts users about occurring power failures.

With one model having an operating temperature of , and another with a wide operating temperature of $-40^{\circ}\text{C} \sim 75^{\circ}\text{C}$, this series is designed to meet any needs for industrial automation, outdoor application and harsh environments.

Software Features

Network Redundancy

- STP, RSTP, MSTP, ITU-T G.8032 Ethernet Ring Protection Switch (ERPS) for network redundancy

Configuration

- Web UI based management, Telnet, Serial Console, Cisco-like CLI, TFTP, SSH, SSL, SNMP v1/v2c/v3, RMON, USB

Network Management

- QoS, traffic classification QoS, Cos, bandwidth control for Ingress and Egress, broadcast storm control, Diffserv
- IEEE802.1Q VLAN, management VLAN supported
- IGMP snooping v1/v2, IGMP filtering / throttling, IGMP query up to 256 group
- DHCP Client/Server/Relay with Option 82
- Internet Protocol Version 6 (IPv6)
- PoE Status, Monitoring
- RMON, MIB II, NTP/SNTP, uPnP, Modbus/TCP

Security Features

- MAC based port security, static MAC address
- Access Control List(ACL), 802.1X authentication, RADIUS
- SNMP v3 encrypted authentication and access

PoE Ports Management

- Port Status, Statistics, Monitoring
- Auto powered device (PD) detection
- Auto reset (cycle power to unresponsive PD)

- PoE ports weekly power scheduling

Port Configuration

- Port Status, Statistics, Monitoring, Mirroring, Security, and Rate Limiting, SFP DDM

Event Handling

- Event notification by Email: Cold/Warm Start, Power Failure, Authentication, SNMP trap and Fault Alarm Relay Output

Software Upgrade

- TFTP, Web GUI, CLI

USB Port

- Configuration Backup

Hardware Features

Interface & Performance

- All Copper ports support auto MDI/MDI-X function
- Embedded 8*10/100/1000Tx (PSE 30W/Port) and 4*100/1000 SFP Slots
- Store-and-forward switching architecture
- 8K MAC Address Table
- Supports 9.6Kbytes Jumbo Frame
- 2,000VDC Power line EFT protection & 6000VDC Ethernet ESD protection

Power Input

- DC 48-55V redundant power

Operating Temperature

- Standard operating temperature model: -10°C ~ 65°C
- Extended operating temperature model (-T): -40°C ~ 75°C

Case/Installation

- IP30 protection
- Installation in pollution degree to environment
- DIN-Rail and Wall mount design

Package Contents

- 1 - LT-PIGE-804GBTME: 12-port industrial PoE+ gigabit managed Ethernet switch, with 8*10/100/1000Tx (PSE 30W/Port) and 4*100/1000 SFP Slots
- 1 - User manual CD
- 2 - Wall mounting brackets and screws
- 1 - RJ45 to DB9 Serial Console cable
- 1 - DC cable - 18 AWG & DC jack 5.5x2.1mm

Safety Precaution

Attention

If the DC voltage is supplied by an external circuit, please use a protection device on the power supply input. Supply by UL Listed industrial use power. The industrial Ethernet switch's hardware specs, ports, cabling information, and wiring installation will be described within this user manual.

Hardware Description

Physical Dimensions

Figure 2.1, below, shows the physical dimensions of LT-PIGE-804GBTME series: 12-port industrial PoE+ gigabit managed Ethernet switch, with 8*10/100/1000Tx (PSE 30W/Port) and 4*100/1000 SFP Slots.

(W x H x D) is 46mm x 142mm x 99mm

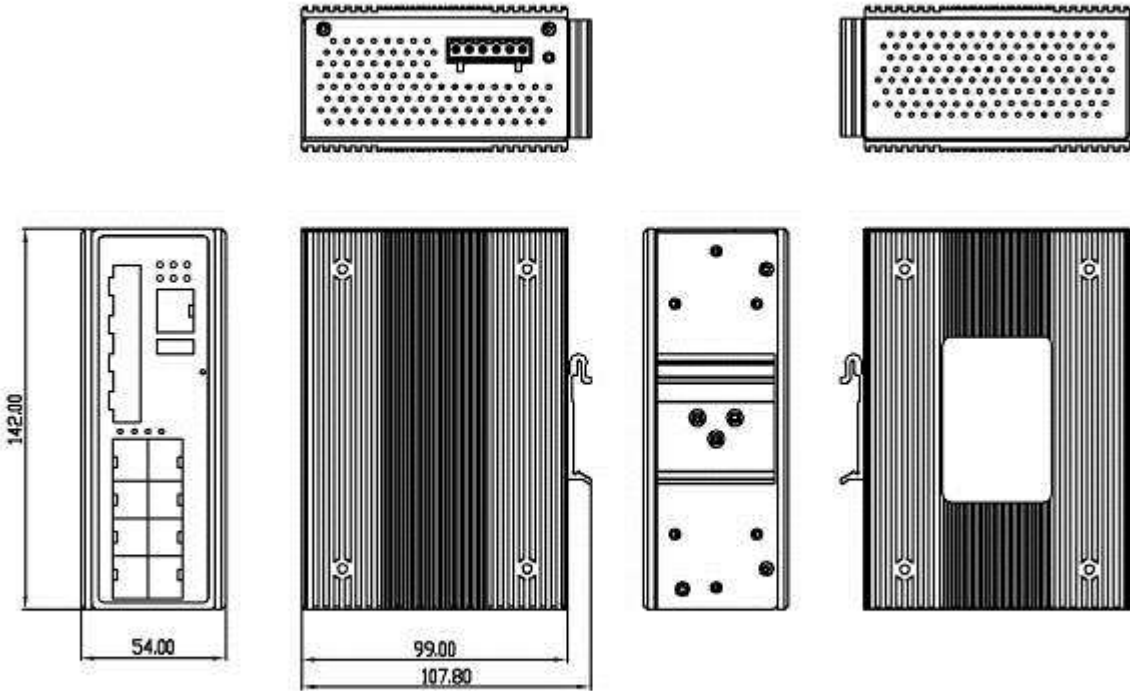

Figure 2.1: LT-PIGE-804GBTME Series Physical Dimensions

Front Panel

The front panel of the LT-PIGE-804GBTME series industrial PoE+ gigabit managed Ethernet switch is shown below in Figure 2.2.

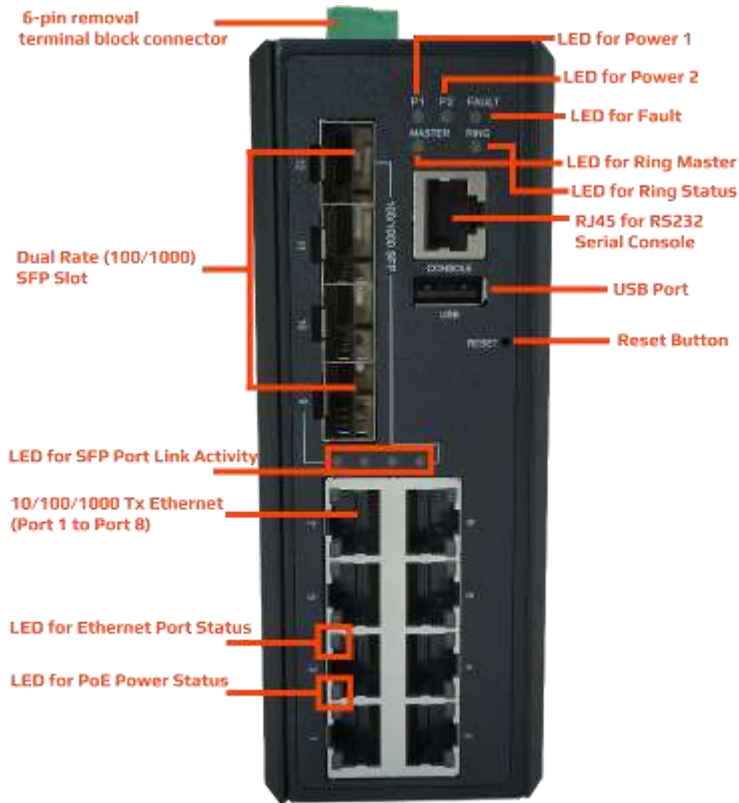

Figure 2.2: The Front Panel of LT-PIGE-804GBTME Series

Top View

Figure 2.3, below, shows the top panel of the LT-PIGE-804GBTME series switch that is equipped with one 6-pin removal terminal block connector for dual DC power inputs (48-55VDC).

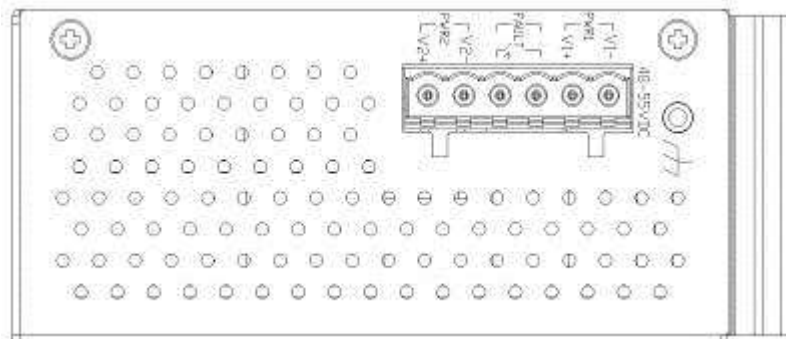

Figure 2.3: Top Panel View of LT-PIGE-804GBTME Series

LED Indicators

There are LED light indicators located on the front panel of the industrial Ethernet switch that display the power status and network status. Each LED indicator has a different color and has its own specific meaning, see below in Table 2.1.



LED	Color	Description	
P1	Green	On	Power input 1 is active
		Off	Power input 1 is inactive
P2	Green	On	Power input 2 is active
		Off	Power input 2 is inactive
Fault	Green	On	System is ready
		Off	System is booting
	Red	On	Fault alarm event triggered
		Off	Normal state
Master	Green	On	ERPS Owner Mode (Ring Master) is ready
		Off	ERPS Owner Mode is not active
Ring	Green	On	Ring Network is active and works well
		Flashing	Ring works abnormally or misconfigure
		Off	Ring Network is not active
LINK/ACT (SFP Port)	Green	On	Connected to network
		Flashing	Networking is active with 1000Mbps
		Off	Not connected to network
	Amber	On	Connected to network
		Flashing	Networking is active with 100Mbps
		Off	Not connected to network
LAN Port 1-8 (Left LED)		On	Connected to network, 10/100/1000Mbps
		Flashing	Networking is active
		Off	Not connected to network
LAN Port 1-8 (Right LED)		On	The port is supplying power to the powered-device
		Off	No powered-device attached or power supplying fails

Table 2.1: LED Indicators for LT-PIGE-804GBTME Series

Ethernet Ports

RJ-45 Ports(Auto MDI/MDIX)

The RJ-45 ports are auto-sensing for 10Base-T, 100Base-TX or 1000Base-T devices connections. Auto MDI/MDIX means that the switch can connect to another switch or workstation without changing the straight-through or crossover cabling. See the figures as below for straight-through and crossover cabling schematics.

RJ-45 Pin Assignments (Table 2.2)

Pin Number	Assignment
1	Rx+
2	Rx-
3	Tx+
6	Tx-

Table 2.2: RJ-45 Pin Assignments

Note: “+” and “-” signs represent the polarity of the wires that make up each wire pair.

All ports on this industrial Ethernet switch support automatic MDI/MDI-X operation. Users can use straight-through cables (see Figure 2.4) for all network connections to PCs, servers, other switches or hubs. With straight-through cable, pins 1, 2, 3, and 6, at one end of the cable, are connected straight through to pins 1, 2, 3 and 6 at the other end of the cable. The table below (Table 2.3) shows the 10BASE-T, 100BASE-TX, 1000BASE-TX MDI and MDI-X port pin outs.

Pin MDI-X	Signal Name	MDI Signal Name
1	Receive Data plus (RD+)	Transmit Data plus (TD+)
2	Receive Data minus (RD-)	Transmit Data minus (TD-)
3	Transmit Data plus (TD+)	Receive Data plus (RD+)
6	Transmit Data minus (TD-)	Receive Data minus (RD-)

Table 2.3: Ethernet Signal Pin Outs

The following figures show the cabling schematics for straight-through and crossover.

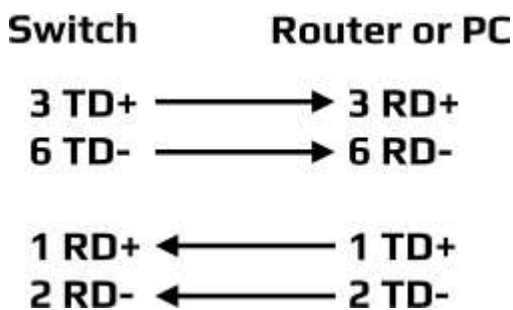

Figure 2.4: Straight-Through Cable Schematic

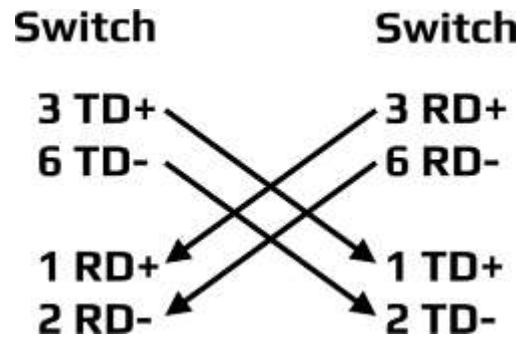

Figure 2.5: Crossover Cable Schematic

The following figures show the 10,100, and 1000 Ethernet RJ-45 pin outs.

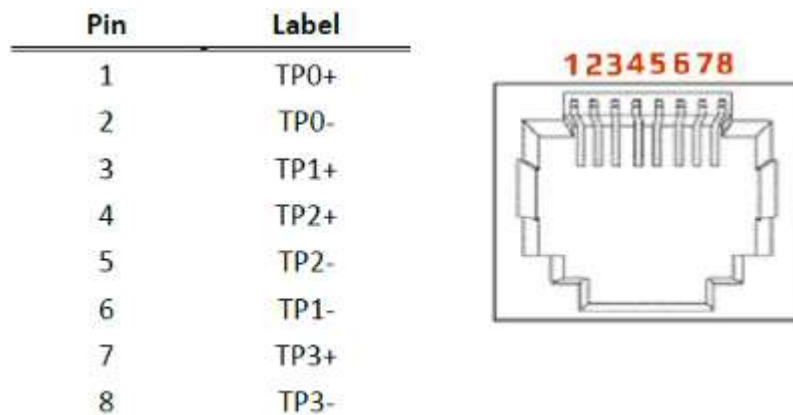
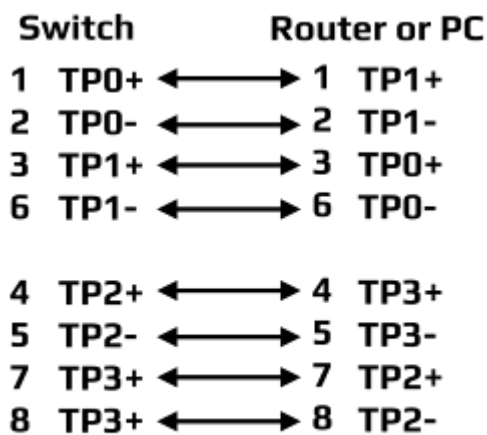
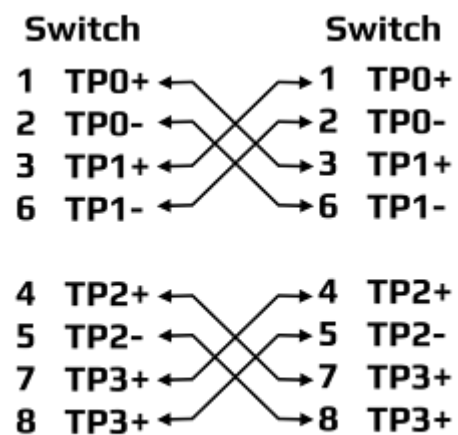

Figure 2.6: RJ45 Ethernet Port Pin Outs



Straight Through Cables Schematic

Figure 2.7: Straight-Through Cable Schematic



Cross Over Cables Schematic

Figure 2.8: Crossover Cable Schematic

Cabling

Use the four twisted-pair, category 5e, or the above cabling for RJ-45 port connections. The cable between the switch and the link partner (switch, hub, workstation, etc.) must be less than 100 meters (328 ft.) long.

The small form-factor pluggable (SFP) is a compact optical transceiver used in optical communications for both telecommunication and data communication applications.

To connect the transceiver and LC cable, please follow below steps:

Step 1. Insert the SFP transceiver module into the SFP slot as shown below in Figure 2.9. Notice that the triangle mark is at the bottom of the SFP slot. Figure 2.10 shows SFP transceiver module was inserted.

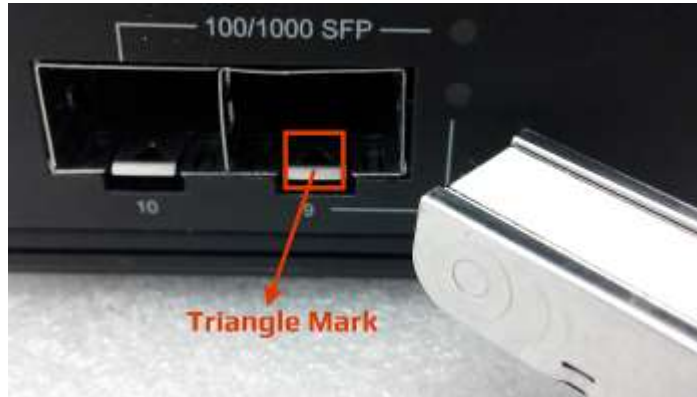

Figure 2.9: Transceiver to the SFP Module

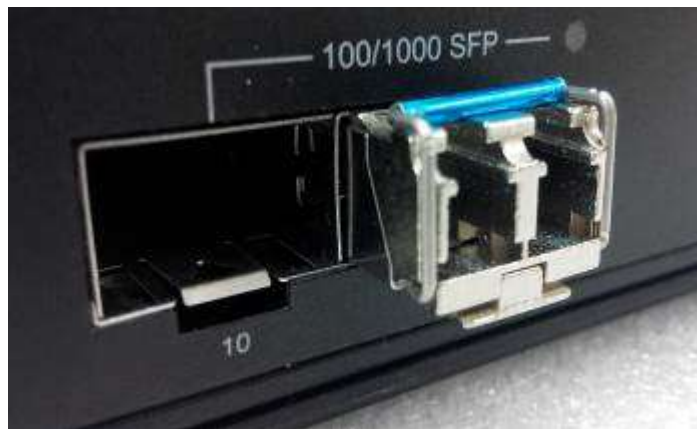

Figure 2.10: Transceiver Inserted

Step 2. Insert the fiber cable of the LC connector into the transceiver as shown below in Figure 2.11.

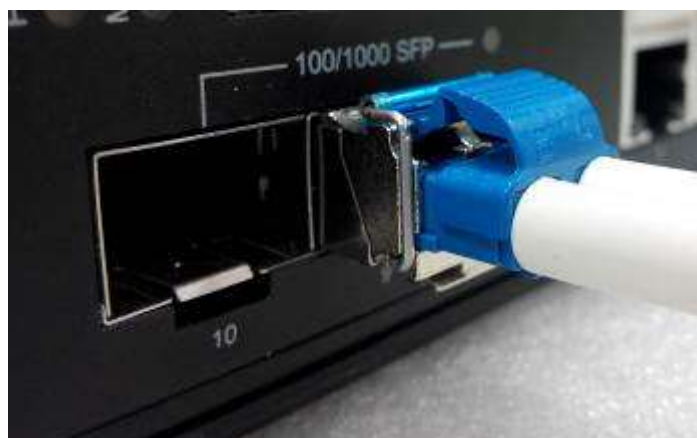

Figure 2.11: LC Connector to the Transceiver

To remove the LC connector from the transceiver, please follow the steps shown below:

Step 1. Press the upper side of the LC connector from the transceiver and pull it out to release as shown below in Figure 2.12

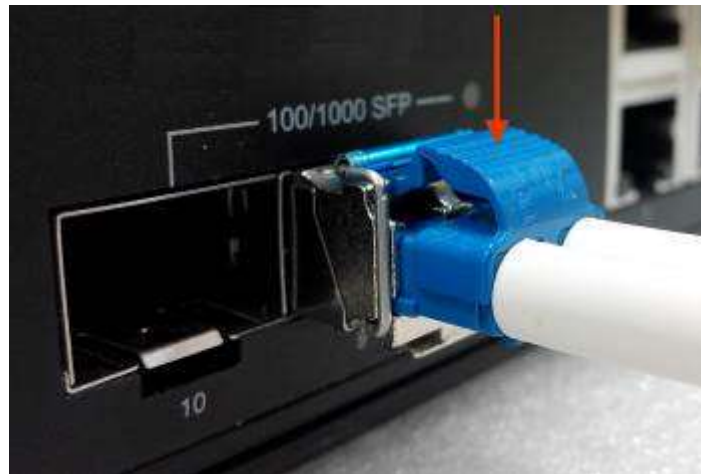

Figure 2.12: Remove LC Connector

Step 2. Push down the metal clasp and pull the transceiver out by the plastic part as shown below in Figure 2.13

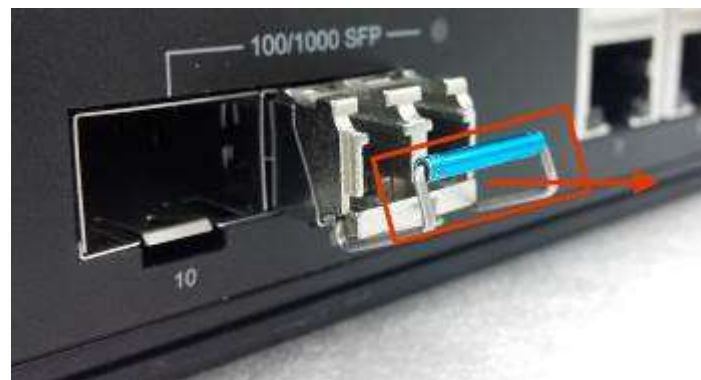

Figure 2.13: Pull Out from the SFP Module

Wiring the Power Inputs

Please follow the below steps to insert the power wire.

Step 1. Insert the positive and negative wires into the PWR1 (V1+, V1-) and PWR2 (V2+, V2-) contacts on the terminal block connector as shown below in Figure 2.14.



Figure 2.14: Power Terminal Block

Step 2. Tighten the wire-clamp screws to prevent the wires from loosening, as shown below in Figure 2.15.



Figure 2.15: Power Terminal Block

Note: Only use copper conductors, **60/75°C**, tighten to **5 lbs**.

The wire gauge for the terminal block should range between **18~20 AWG**.

Wiring the Fault Alarm Contact

The fault alarm contact is in the middle of the terminal block connector as the picture shows below in Figure 2.16. By inserting the wires, it will detect the fault status including power failure or port link failure (managed industrial switch only) and form a normally open circuit. An application example for the fault alarm contact is shown below in Figure 2.16.

Insert the wires into the fault alarm contact (No. 3&4)

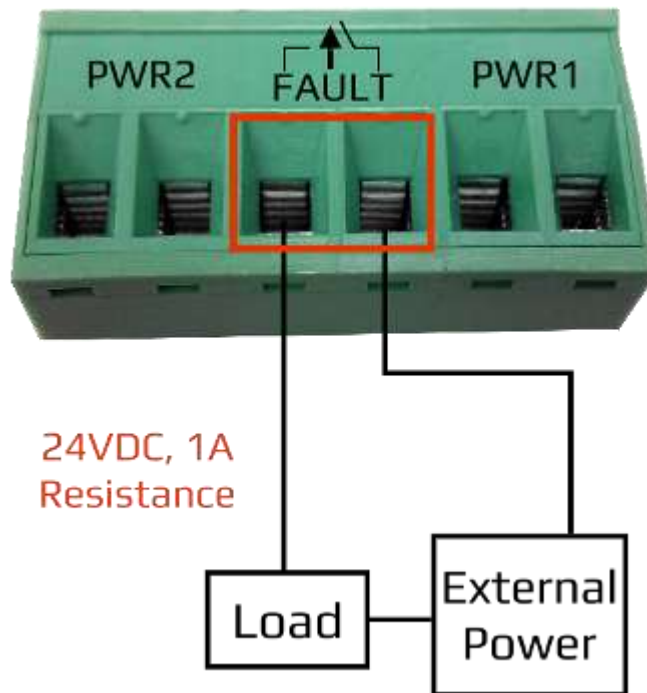

Figure 2.16: Wiring the Fault Alarm Contact

Note: The wire gauge for the terminal block should range between **12 ~ 24 AWG**.

If only using one power source, jumper Pin 1 to Pin 5 and Pin 2 to Pin 6 to eliminate power fault alarm.

Mounting Installation

DIN-Rail Mounting

The DIN-Rail is pre-installed on the industrial Ethernet switch from the factory. If the DIN-Rail is not on the industrial Ethernet switch, please see Figure 3.1 to learn how to install the DIN-Rail on the switch.



Figure 3.1: The Rear Side of the Switch and DIN-Rail Bracket

Follow the steps below to learn how to hang the industrial Ethernet switch.

Step 1. Use the screws to install the DIN-Rail bracket on the rear side of the industrial Ethernet switch.

Step 2. To remove the DIN-Rail bracket, do the opposite from Step 1.

Step 3. After the DIN-Rail bracket is installed on the rear side of the switch, insert the top of the DIN-Rail on to the track as shown below in Figure 3.2.



Figure 3.2: Insert the Switch on the DIN-Rail

Step 4. Lightly pull down the bracket on to the rail as shown below in Figure 3.3.

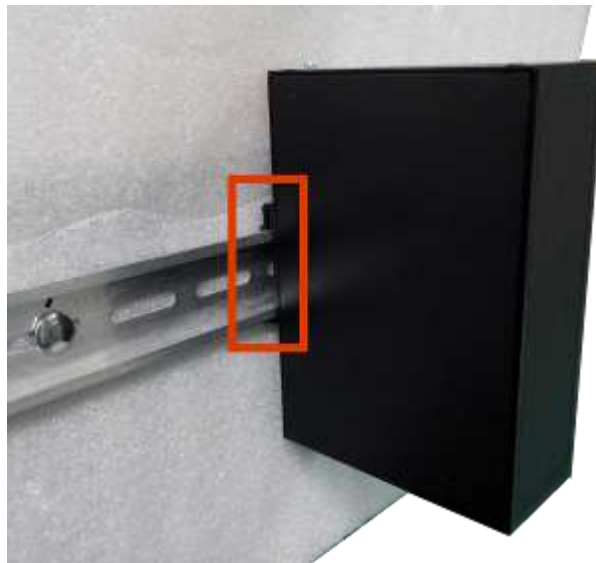

Figure 3.3: Stable the Switch on DIN-Rail

Step 5. Check if the bracket is mounted tightly on the rail.

Step 6. To remove the industrial Ethernet switch from the rail, do the opposite from the above steps.

Wall Mounting

Follow the steps below to mount the industrial Ethernet switch using the wall mounting bracket as shown below in Figure 3.4.

Step 1. Remove the DIN-Rail bracket from the industrial Ethernet switch by loosening the screws.

Step 2. Place the wall mounting brackets on the top and bottom of the industrial Ethernet switch.

Step 3. Use the screws to screw the wall mounting bracket on the industrial Ethernet switch.

Step 4. Use the hook holes at the corners of the wall mounting bracket to hang the industrial Ethernet switch on the wall.

Step 5. To remove the wall mount bracket, do the opposite from the steps above.



Figure 3.4: Remove DIN-Rail Bracket from the Switch

Below, in Figure 3.5 are the dimensions of the wall mounting bracket.

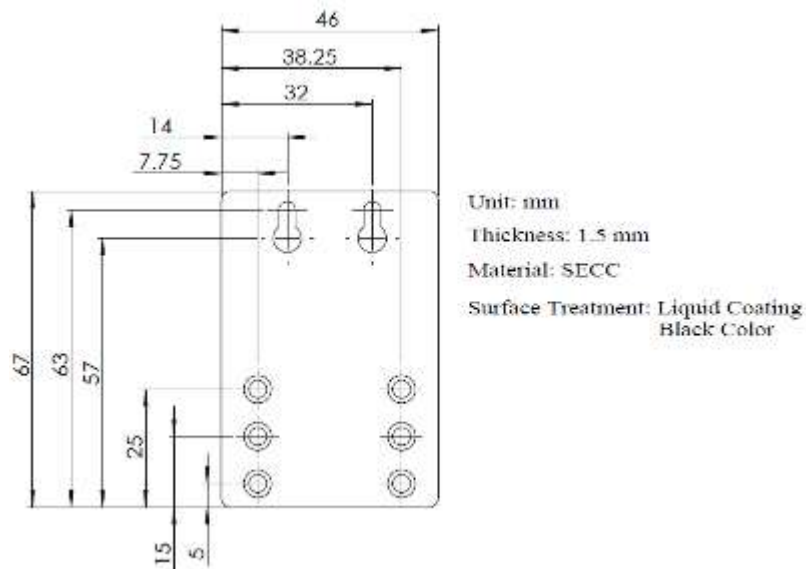

Figure 3.5: Wall Mounting Bracket Dimensions

Hardware Installation

Installation Steps

This section will explain how to install LT-PIGE-804GBTME series: 12-port industrial PoE+ gigabit managed Ethernet switch, with 8*10/100/1000Tx (PSE 30W/Port) and 4*100/1000 SFP Slots

Installation Steps

Step 1. Unpack the industrial Ethernet switch from the original packing box.

Step 2. Check if the DIN-Rail bracket is screwed on the industrial Ethernet switch.

- If the DIN-Rail is not screwed on the industrial Ethernet switch, please refer to the **DIN-Rail Mounting** section for DIN-Rail installation.
- If you want to wall mount the industrial Ethernet switch, please refer to the **Wall Mounting** section for wall mounting installation.

Step 3. To hang the industrial Ethernet switch on a DIN-Rail or wall, please refer to the **Mounting Installation** section.

Step 4. Power on the industrial Ethernet switch and then the power LED light will turn on.

- If you need help on how to wire power, please refer to the **Wiring the Power Inputs** section.
- Please refer to the **LED Indicators** section for LED light indication.

Step 5. Prepare the twisted-pair, straight-through category 5 cable for Ethernet connection.

Step 6. Insert one side of the RJ-45 cable into switch's Ethernet port and on the other side into the networking device's Ethernet port, e.g. switch PC or server. The Ethernet port's (RJ-45) LED on the industrial Ethernet switch will turn on when the cable is connected to the networking device.

- Please refer to the **LED Indicators** section for LED light indication.

Step 7. When all connections are set and the LED lights all show normal, the installation is complete.

Trouble Shooting

- Verify you have the right power cord or adapter. Never use a power supply or adapter with a non-compliant DC output voltage or it will burn the equipment.
- Select the proper UTP or STP cable in order to construct the network. Use an unshielded twisted-pair (UTP) or shield twisted-pair (STP) cable for RJ-45 connections: 100Ω Category 5e for 10M/100Mbps. Also be sure that the length of any twisted-pair connection does not exceed 100 meters (328 feet).
- Diagnosing LED Indicators: To assist in identifying problems, the switch can be easily monitored with the LED indicators which help to identify if any problems exist.
 - ◆ Please refer to the LED Indicators section for LED light indication.
- If the power indicator LED does not turn on when the power cord is plugged in, the user may have a problem with the power cord. Check for loose power connections, power losses or surges at the power outlet.
 - ◆ Please contact Leonton for technical support service, if the problem still cannot be resolved.
- If the industrial switch LED indicators are normal and the connected cables are correct but the packets still cannot transmit, please check the system's Ethernet devices' configuration or status.

Technical Specification

Table 7.1 has the technical specifications for LT-PIGE-804GBTME series: 12-port industrial PoE+ gigabit managed Ethernet switch, with 8*10/100/1000Tx (PSE 30W/Port) and 4*100/1000 SFP Slots

Standard	<p>IEEE 802.3 10BaseT Ethernet</p> <p>IEEE 802.3u 100BaseTX Fast Ethernet</p> <p>IEEE 802.3ab 1000BaseT</p> <p>IEEE 802.3z 1000Base-X</p> <p>IEEE 802.3af/at Power over Ethernet</p> <p>IEEE 802.3x flow control</p> <p>IEEE 802.1d STP (Spanning Tree Protocol)</p> <p>IEEE 802.1w RSTP (Rapid Spanning Tree Protocol)</p> <p>IEEE 802.1s MSTP (Multiple Spanning Tree Protocol)</p> <p>ITU-TG.8032 / Y.1344 ERPS (Ethernet Ring Protection Switch)</p> <p>IEEE 802.1Q Virtual Local Area Network (VLAN)</p> <p>IEEE 802.1ad Stacked VLAN, Q-in-Q</p> <p>IEEE 802.1p QoS/CoS Protocol for Traffic Prioritization</p> <p>IEEE 802.1X Network Authentication</p>
Protocol	CSMA/CD, IGMP v1/v2, SNMP v1/v2c/v3, TFTP, SNTP, SMTP, RARP, RMON, Syslog
Data Process	Store and Forward
Transfer Rate	<p>14,880pps for Ethernet Port</p> <p>14,8800pps for fast Ethernet Port</p> <p>14,88000pps for gigabit Ethernet Port</p>
Transmission Distance	Up to 100M (Fast Ethernet)
Transmission Speed	Up to 1000Mbps (RJ45 Port)
Memory Buffer	4Mbits
MAC Address	8K
Jumbo Frame	9.6Kbytes
RJ-45 (Ethernet) Port	(PSE 30W/Port), auto negotiation speed, full/half duplex mode, and auto MDI/MDI-X connection
PoE Pin Assignment	<p>RJ-45 port #1 ~ #8 support IEEE 802.3at end-point, alternative A mode.</p> <p>Positive (VCC+): Pin 1, 2</p> <p>Negative (VCC-): RJ-45 pin 3, 6</p>

	Data: Pin 1, 2, 3, 6
SFP Slot	4*SFP slots support dual rate 100/1000
LED	P1 (Green), P2 (Green), Fault(Green/Red) Ethernet port: Link/active(Green) SFP: Link/active(Green/Amber)
Network Cable	10BaseT: 2-pair UTP/STP Cat. 3, 4, 5 cable EIA/TIA-568 100-ohm (100m) 100BaseTX: 2-pair UTP/STP Cat. 5 cable EIA/TIA-568 100-ohm (100m) 1000BaseTX: UTP/STP Cat. 5/5E cable EIA/TIA-568 100-ohm (100m)
Over Current Protection	Present(Slow-Blown Fuse)
Power Reverse Polarity Protection	Present
CPU Watch Dog	Present
Power Input	Redundant power DC 48-55V with connective 1*6-pin removable terminal block
Fault Output	1 Relay output
Max Power Consumption	215 Watts @ 48VDC; 255 Watts @ 51~55VDC Full load with PoE function
Installation	DIN-Rail mounting and Wall mounting
Operating Temperature	Standard: -10°C ~ 65°C (14°F to 149°F) EOT: -40°C ~ 75°C (-40°F to 167°F)
Operating Humidity	5% to 95% (Non-Condensing)
Storage Temperature	-40°C ~ 85°C (-40°F to 185°F)
Case Dimension	IP-30, 46mm (W) x 142mm (H) x 99mm (D)
EMI/EMS	FCC Part 15 Subpart B and CISPR 22, Class A CE EN55022 Class A ; EN55024 CE EN61000-4-2/3/4/5/6/8 CE EN61000-6-2, Emission for industrial environment CE EN61000-6-4, Immunity for Industrial environment
Stability Testing	IEC60068-2-32 (Free fall) IEC60068-2-27 (Shock) IEC60068-2-6 (Vibration)
Safety	UL 508 (Pending)

Table 7.1: LT-PIGE-804GBTME Series Technical Specification